

Optimal Configuration of Distributed Generation on Jeju Island Power Grid Using Genetic Algorithm: A Case Study

Rui Huang, Yubo Wang, Chi-Cheng Chu, Rajit Gadh, and Yu-jin Song

Abstract—With the rapid development of wind turbine, photovoltaic and battery technologies, renewable energy resources such as wind and solar become the most common distributed generations (DG) that are being integrated into microgrids. One key impediment is to determine the sizes and placements of DGs within which the microgrid can achieve its maximum potential benefits. The objective of the paper is to study and propose an approach to find the optimal sizes and placements of DGs in a microgrid. The authors propose a comprehensive objective function with practical constraints which take all the important factors that will impact the reliability of the power grid into account. To solve the optimization problem, genetic algorithm (GA) is used and compared with a mathematical optimization method nonlinear programming. The proposed model is tested on a real microgrid, i.e. Jeju Island, to evaluate and validate the performances of the approach. The simulation results present the optimal configuration of DGs for Jeju Island power grid. The analysis on results shows that GA maintains a delicate balance between performance and complexity. It is concluded that GA performs better not only in accuracy, stability, but also in computation time.

Index Terms—distributed generation, optimization, genetic algorithm

I. INTRODUCTION

Existing traditional power grids are constantly facing reliable problems, therefore new research on developing a Smart Grid has been started and became popular in the past decades. In the concept of Smart Grid, new ideas are applied into each part of traditional power grid. For example, on supply side, renewable resources are integrated and storage systems are installed. Demand response and energy efficiency technologies are used in demand side management. In such a Smart Grid, decentralized control and communication network is another important factor, which can realize intelligent coordination with new components and new technologies. A microgrid that can be connected to main grid and disconnected to be an isolated system, is a good test bed for the realization of Smart Grid.

Distributed generation (DG) is heatedly studied among researchers in the field of Smart Grid and microgrid, as

energy crisis and waste pollution by traditional generation are threatening the future of mankind. With the rapid development of wind turbine (WT), photovoltaic (PV) and battery (BA) technologies, renewable energy resources such as wind and solar catch plenty of attentions as alternative solution and become the most common DGs that are being integrated into microgrids [1]. However, it is still challenging to properly integrate them such as that the renewable energies are intermittent and uncertain, and high penetration will cause impact on system stability. One key impediment is to determine the sizes and placements of DGs within which the microgrid can achieve its maximum potential benefits [2].

Jeju Province is the largest island in South Korea, which is 714 square miles in area, with a length of 45.5 miles and a width of 39.8 miles. Currently, electricity is mainly generated by generators in thermal plants and WTs in wind farms (WF) on the island while its power grid is connected to Korea mainland via High Voltage Direct Current (HVDC) systems [3]. Jeju Island is an ideal place to integrate DGs due to its geological advantages—mild temperature and plenty of wind and sunshine. Jeju Global Research Center (JGRC) of Korea Institute of Energy Research (KIER), as one of the research test beds on the island, was established on January 1, 2011 with the vision of open innovation and global cooperation on developing convergence technologies in the field of wind, solar and storage together¹. The desirable hybrid energy system on the island is composed of WTs, solar PV panels, Li-ion BA storage units, back-up generation such as diesel, electric double-layer capacitor (EDLC), redox flow battery (RFB), active power filter (APF) and residential loads such as vehicle-to-grid (V2G) capable Electric Vehicles (EVs) and various appliances.

The objective of the paper is to study and propose an approach to find the optimal sizes and placements of DGs in a microgrid. To solve the optimization problem, genetic algorithm (GA), which is a type of heuristic evolutionary optimization methodologies, is used and compared with a mathematical optimization method nonlinear programming (NLP). The important contributions of the paper are the following: first of all, this paper proposes a comprehensive objective function with practical constraints which take all the important factors that will impact the reliability of the power grid into account. Secondly, GA is used to solve the

Manuscript received March 31, 2014; revised May 31, 2014.

This work is supported by Korea Institute of Energy Research (KIER), South Korea, with grant number 20112310 and Smart Grid Energy Research Center (SMERC), UCLA.

Authors are with University of California Los Angeles, CA, U.S.A. and Korea Institute of Energy Research, South Korea. Emails: {rhuang, ybwang, peterchu, gadh}@ucla.edu, eugeneseong@kier.re.kr.

¹http://www.kier.re.kr/eng/03_activities/jeju.jsp

optimization problem. The results are carefully compared with NLP. The analysis shows that GA maintains a delicate balance between performance and complexity. Thirdly, the proposed model is tested on a real microgrid, i.e. Jeju Island, to evaluate and validate the performances of the approach. The real case study and analysis also sheds light on design and robust operation of microgrid with DGs. Most importantly, though WTs have been already installed on the island and studies on analyzing the impact on the system stability due to wind penetration are done, unfortunately, few research that takes wind, solar and BA into account together and analyzes the optimal sizes and placements of DGs using the island as test bed, has been carried out. This paper focuses on solving the problem for Jeju Island power grid by considering and combining all the important DGs together.

In the paper, a literature review on the current status of research on optimizing DGs in hybrid energy system is investigated in Section II. Before planning ahead, the original system topology is presented in Section III. In addition, historical wind, solar and load profiles are collected and details of modeling the wind, solar generation, BA management algorithm and demand profiles are presented in this section as well. The optimization problem is formulated in Section IV including an introduction to GA. In Section V, simulation results with charts and figures of the best combinations of DGs by two methods are presented with details of quantitative explanations. It is followed by Section VI that discusses the conclusions and future work.

II. LITERATURE REVIEW

In the section, the authors carry out an insightful review on the current state of art on the methods of solving multi-objective optimization problem. In paper [2], an overview in computational optimization methods in the field of renewable sustainable energy is provided. The methods that are used to solve the optimization problem can be divided into two categories—classical and heuristic approaches. Classical approaches include linear programming (LP), nonlinear programming (NLP) and Lagrangian relaxation (LR), etc., while heuristic approaches include simulated annealing (SA), evolutionary algorithm (EA), genetic algorithm (GA) and artificial neural network (ANN). Compared to traditional methods, heuristic approaches are considered to be a more promising research area, especially in the field of optimizing DGs.

When designing a microgrid with optimal DGs, sizes and placements both play critical roles. Regarding to optimal sizing, a summary of the unit sizing optimization methods is presented in paper [4]. Many researches has been done on optimal sizing by different methods. The sizing optimization problems are solved by methods of LR, SA and EA respectively [5]-[7]. In particular, GA is used a lot in solving the optimal sizing problem [8]-[11]. However, the above papers either fails to jointly optimize sizing and placement or make a comparison among different optimization methods.

On the contrary, many researchers focus on the optimal allocations of DGs instead of sizing. A literature review is investigated and lists the current strategies on optimal

placements of DGs [12]. Analytic approach, adaptive weight particle swarm optimization (AWPSO) and EA respectively are used in solving the problem and perform well [13]-[15]. In particular, GA has been widely used to solve the optimal placement problem [16]-[19]. Similarly, the cons for these papers are that they only consider optimizing placements and do not compare the performances of the approaches.

A complete optimal integrating DGs should consider both of sizes and placements together. A review on optimal planning of sizes and locations together is presented [20]. The optimal sizes and allocations using multi-objective NLP optimization approach is solved [21]. Sequential quadratic programming algorithm (SQP) is used in paper [22] to optimize the two factors while both optimizations are solved in paper [23] by taking weighting factors into account. The optimal sizes and placements of DG are found by using GA in paper [24] and [25]. But neither of these above-mentioned papers discuss the comparison among different methods.

III. SYSTEM MODELING

A. Power System on Jeju Island

As a popular tourist destination, Jeju Island has a population of 583,284 and residential households of 227,873. The power system on the island is not huge but contains all the same elements, i.e., generations, transmission lines, distribution systems and loads as in common power grids. However, the power system needs improvement due to gradually increasing demands. As for now, the total annual electricity usage on the island was 4,039,830 *MWh* and the average daily usage was 11,068 *MWh*². Table I presents the statistical data about generation and consumption on Jeju Island from Year 2009 to 2013 [26]-[28]. From the table, a power system integrated with optimal DGs is expected. With the optimization on DGs, the new power system on Jeju Island will be more environmentally friendly without spending too much on construction and maintenance, as well as that the system balance will be more easily kept.

Table I
STATISTICS OF THE POWER SYSTEM ON JEJU ISLAND IN YEAR 2009, 2011
AND 2013 (*MW*)

Year	Thermal	HVDC	Wind	Solar	Total Generation	Load
2009	679	150	83	0	912	150
2011	679	300	150	0	1129	335
2013	679	350	300	3	1332	675

Fig. 1 presents the original topology of the power system on Jeju Island in 2013, which shows the elements in the existing power system [3], [26]-[29]. To be specific, there are two thermal plants which consist of 400 *MW* diesel generators and 279 *MW* steam turbines, respectively located at the north and south of the island. The production by thermal plants has been served as basic constant supply in the past few years. Two HVDC systems with capacities of 150 *MW* and 200 *MW* are connecting the island with Korea mainland. There are three main WFs belonging to several research centers,

²<http://english.jeju.go.kr/index.php/contents/AboutJeju/intro/statistics>

mainly located at the northeast and southwest of the island, with a large number of WTs already been integrated into the power system. Various residential loads are distributed at five different areas on the island, as the figure shows.

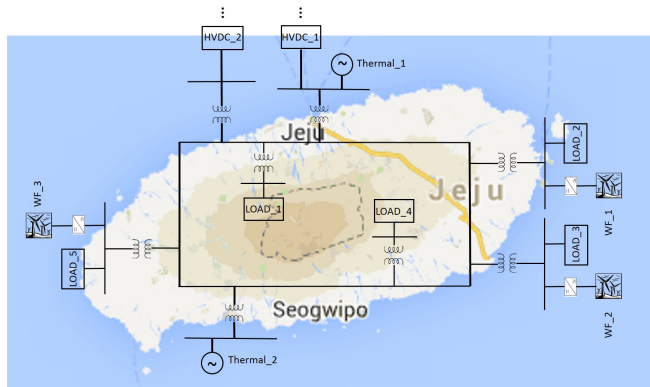

Figure 1. Original topology of the power system on Jeju Island

Based on the original topology, the authors consider proposing an improved system with adding WTs, solar PV panels, Li-ion BA storage units and back-up generation such as diesel, EDLC, RFB and APF with fixed capacity. Fig. 2 shows the desirable schematic diagram. The optimal configuration of DGs including sizes and placements needs to be determined, in order to satisfy the residential loads such as EVs and various appliances. In the following, the modeling on each DG is discussed.

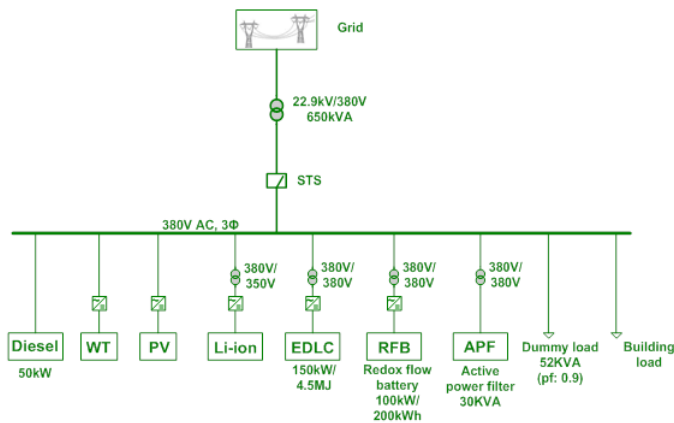

Figure 2. Desirable topology of the power system after the integration of DGs on Jeju Island

B. Wind Power Generation

Wind is one of key renewable energies on Jeju Island. Previous studies and existing implementations have demonstrated its benefits to the entire system. Before discussing the modeling on wind power generation, the historical wind data is analyzed, which is obtained at two measurement spots from the KIER test bed on Jeju Island and measured every second on April 7th, 2012. Spot 1 is located at the northeast of the island and spot 2 is located at the southwest of the island. The raw data illustrates that wind energy on the

island approximately follows normal distributions with mean of 12.4692 and standard deviation of 5.4576 for spot 1, and mean of 8.1346 and standard deviation of 3.1543 for spot 2 [26], [31]. Fig. 3 and Fig. 4 respectively show the simulated hourly wind speed at two spots on April 7th, 2013 and in Year 2013. In 2013, the highest wind speed is 35 m/s for spot 1 and 20 m/s for spot 2.

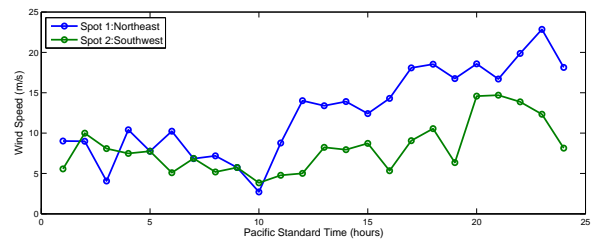

Figure 3. Hourly wind speed on April 7th, 2012 on Jeju Island

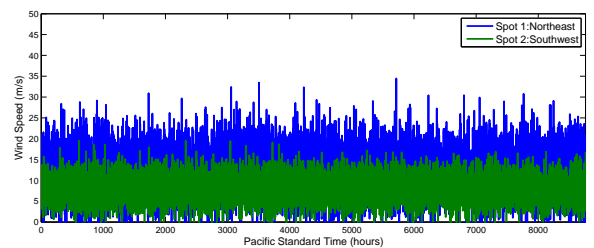

Figure 4. Hourly wind speed in Year 2012 on Jeju Island

The mathematical algorithm of modeling the wind power generation is presented in Equation 1 [32]. In the equation, P_W is the power (MW) generated by 1 MW WTs, $C_W = 0.25\%$ is the power coefficient that adjusts the power generation based on the hardware specification, $\rho = 1.225kg/m^3$ is the air density, v_i is the wind speed (m/s) at spot i ($i = 1, 2$) and $A_W = 4,000m^2$ is the area of 1 MW WTs [26]. The wind power generation reaches and maintains peak amount around 1 MW after wind speed is higher than 30 m/s. The total capacity of WTs (MW) is one variable that needs to be optimized. The optimal placement is chosen from two measurement spots.

$$P_W = \frac{1}{2} C_W \rho v_i^3 A_w \quad (1)$$

C. Solar Power Generation

Currently, solar is still under developed on Jeju Island. But it is very prospective that solar can solve the energy crisis and benefit the environment. Korean Government also points out that solar is essential in the future power system on Jeju Island. The historical solar data is pre-analyzed as well. The raw data including Global Horizontal Irradiation (GHI) and Direct Normal Irradiation (DNI) is obtained at a measurement spot (the same location as spot 1 in Section III-B) from the KIER test bed on Jeju Island and measured every second on April 7th, 2012. The authors study the analysis on the solar energy

of South Korea by National Renewable Energy Laboratory and simulate the hourly solar irradiation at the spot on April 7th, 2013 and in Year 2013, as Fig. 5 and Fig. 6 show³ [34]. In 2013, the average solar irradiation is 196 W/m^2 and the strongest solar irradiation is 1009 W/m^2 for spot 1.

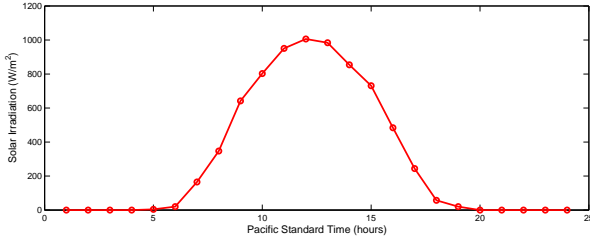

Figure 5. Hourly solar irradiation on April 7th, 2012 on Jeju Island

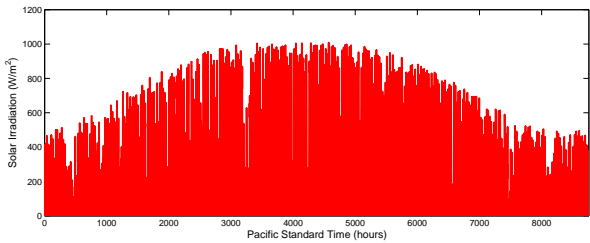

Figure 6. Hourly solar irradiation in Year 2012 on Jeju Island

The mathematical algorithm of modeling the solar power generation is presented in Equation 2 [33]-[35]. In the equation, P_S is the power (MW) generated by 1 MW PVs, $C_S = 0.6$ is the power coefficient that adjusts the solar irradiation based on the hardware specification, R is the solar irradiation (W/m^2), $A_S = 10,000\text{m}^2$ is the area of 1 MW PVs and $\eta = 16.5\%$ is the efficiency with which PV is transforming solar into electricity. The total capacity of PVs (MW) is one variable that needs to be optimized. The placement is fixed at the measurement spot due to limitation on the current hardware installation.

$$P_S = C_S R A_S \eta \quad (2)$$

D. Battery Storage Management

Due to the intermittency and uncertainty of renewable energy, a BA storage management system is required, in order to store the excess and provide the demand. In the paper, the authors propose a simple deterministic BA control algorithm to assist the microgrid [1]. The performance of the algorithm is tested on the Smart Grid Energy Research Center (SMERC) Microgrid, at University of California, Los Angeles (UCLA) [34]. Table II defines and describes the parameters in the algorithm. The total capacity of BA (MW) is one variable that needs to be optimized. The candidate placements of BA are spot 1 and spot 2 as well. The difference due to different spots for BA is the amount of power loss by the transmission.

Table II

SPECIFICATIONS OF THE PARAMETERS IN THE BA CONTROL ALGORITHM

Parameters	Description	Set Value
B	Capacity of the BA	variable
B_I	The initial state of charge (SOC) in the BA	$0.9B$
$S(t)$	The amount of energy supplied at time t	N.A.
$D(t)$	The amount of load at time t	N.A.
$B(t)$	The amount of energy in the BA at time t	N.A.
γ	charging/discharging efficiency	80%
b^-	The maximum SOC in the BA	$0.9B$
b_+	The minimum SOC in the BA	$0.1B$

With the contents in the table, the control algorithm follows the recursion form:

$$B(t+1) = B(t) + f(B(t), S(t) - D(t)) \quad (3)$$

To be specific, the function f is expressed as below. If $S(t) > D(t)$, excess supply is to be charged into BA, then $f = f_1(B(t) + \gamma(S(t) - D(t)), b^-)$. If $S(t) < D(t)$, BA needs to discharge energy to feed the loads, then $f = f_2(B(t) - \frac{1}{\gamma}(D(t) - S(t)), b_+)$. The functions f_1 and f_2 depend on the difference between the SOC after charge/discharge and the required maximum/minimum SOC. In detail, Equation 4 and 5 respectively explain how to calculate the amount of energy that is charged or discharged finally.

$$f_1 = \begin{cases} \gamma(S(t) - D(t)) & \text{if } B(t) + \gamma(S(t) - D(t)) < b^- \\ b^- - B(t) & \text{otherwise.} \end{cases} \quad (4)$$

$$f_2 = \begin{cases} \frac{1}{\gamma}(S(t) - D(t)) & \text{if } B(t) - \frac{1}{\gamma}(D(t) - S(t)) > b_+ \\ b_+ - B(t) & \text{otherwise.} \end{cases} \quad (5)$$

E. Demand Profiles

For $D(t)$ in Section III-D, the authors use the demand profile generated from the historical load data on Jeju Island. The raw data is obtained from the KIER test bed on Jeju Island and measured every second on April 7th, 2012. Based on the real data, a method of modeling different types of loads is used to separate the one-day total demand into four types of loads [36]. Fig. 7 shows the four types of demand patterns with their own characteristics on April 7th, 2013. The first type is the appliances that change their consumption as the temperature changes, such as air conditioners (AC). At daytime between 11 AM to 3 PM in summer, ACs consume more energy because the temperature is higher. The second type of loads are those whose power consumption can keep high for a period of time because customers require that the task should be completed before the deadline. For example, customers have to charge their EVs at night when they are at home. The third type includes LED lightings that the usage amount keeps horizontal while the fourth type include TVs which customers use periodically whenever they want to. The summation of the four major types of loads forms the total representative demand curve. With the separation of the four loads, the authors simulate an hourly demand profile for the

³<http://en.openei.org/w/index.php?title=File:NREL-asia-glo.pdf>

entire year 2013 with consideration of seasonal variations, as Fig. 8 shows. In 2013, the peak demand approaches 675 MW as described in Table I.

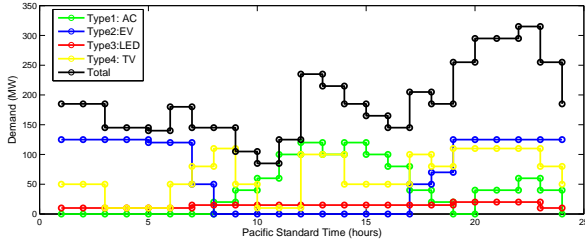

Figure 7. Hourly demand on April 7th, 2012 on Jeju Island

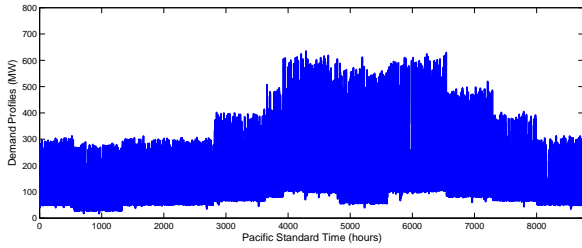

Figure 8. Hourly demand in Year 2012 on Jeju Island

IV. PROBLEM FORMULATION

A. Concept of Load-shedding

Before formulating the problem, an important concept is introduced—Load-Shedding (LS). It is defined that a LS event happens in an isolated power system when demand exceeds supply plus energy that BA can provide by applying the control algorithm in III-D [1]. Equation 6 defines the concept mathematically. In a time horizon of one year by hour ($365 \times 24 = 8760$ hours), Probability of LS is calculated by Equation 7, where $t_i = 1$ if it falls in LS asset and $t_i = 0$ if it does not. The index is often used as the measure of the performance of a power system. A reliable power system can only tolerate small $Prob_{LS}$, e.g. 3% [9], [37].

$$LS := \left\{ t \mid B(t) - b_- < \frac{D(t) - S(t)}{\gamma} \right\} \quad (6)$$

$$Prob_{LS} = \frac{\sum_{i=1}^{8760} t_i}{8760} \quad (7)$$

B. Optimization Problem

The optimization problem is presented in Equation 8. A few assumptions are taken into account here:

- Because $Prob_{LS}$ is used to measure the reliability of the configuration, HVDC systems are excluded thus the power system of Jeju Island is viewed as isolated micro-grid at this stage.

- The supply from the existing WTs on the island has already been subtracted from the total demand. In this case, the authors only need to consider adding new WTs.
- The capacity of thermal plants from diesel and steam can be variable but limited to a certain value, in order to reduce CO_2 emission.

$$\begin{aligned} \min \quad & C \\ \text{s.t.} \quad & (\alpha_i, l_i) \in \Omega \\ & P_{Loss} \leq P_{original} \\ & V_{min} \leq V_i \leq V_{max} \\ & Prob_{LS} \leq \epsilon \end{aligned} \quad (8)$$

The details of the problem formulation are discussed as below.

Decision Variables: In the problem, both of sizes and placements of DGs including WTs, PVs and BAs should be optimized. The decision variables include α_W (the capacity of WTs), α_S (the capacity of PVs), B (the capacity of BA), α_T (the capacity of thermal plants), l_W (the placement of WTs) and l_B (the placement of BA). The reason that the size of thermal generation is also taken into consideration is that reducing CO_2 emission is one target to protect the environment. Once the decision variables are determined, the amount of supply at time t is $S(t) = \alpha_W P_W(t) + \alpha_S P_S(t) + \alpha_T$.

Objective Function: The objective function takes C , the cost to integrate, operate and maintain DGs that is expressed in Equation 9, into consideration. Table III shows the value of the unit cost for each type of DG that is used to calculate [1], [40]-[41].

$$C = C_W \alpha_W + C_S \alpha_S + C_B B \quad (9)$$

Table III
THE VALUE OF THE UNIT COST FOR DGs IN THE OBJECTIVE FUNCTION

DG	Installation
WT	$C_W = 3\$/W$
PV	$C_S = 4\$/W$
BA	$C_B = 200\$/kWh$

Constraints: There are four constraints in Equation 8.

- The constraints on the ranges of decision variables that are shown in Table IV, which is Ω : The size of thermal generation is limited to 100MW in order to reduce the emission of CO_2 . Due to the hardware installation limitation, the placement of PV is fixed at spot 1. The placements of WT and BA are chosen from spot 1 and spot 2.
- The limitation on the power loss caused by transmission and distributions: The power loss after integration of DGs should be less than the original one due to the DG is distributed locally.
- The operation constraints on the voltage stability at each bus (V_i) under IEEE 1547 [38].
- The constraint on the power flow stability, which requires the probability of load-shedding is equal or smaller than an acceptable risk level ϵ . The LS concept is discussed in IV-A. $\epsilon = 3\%$ is chosen in the simulations in Section V.

Table IV
THE RANGES OF DGS IN THE CONSTRAINTS

DG	Size	Placement
WT	0-800 MW	spot 1, spot 2
PV	0-800 MW	spot 1
BA	0-500 MWh	spot 1, spot 2
Thermal	0-100 MW	spot 1

C. Genetic Algorithm

Genetic algorithm is an approach that is used to find the optimal solution to computational problem, which was derived from evolutionary biology based on natural selection process [39]. It has been applied in various research areas such as biology, statistics, computer science, electrical engineering and so on. During GA process, an initial population is randomly selected and generations of chromosomes are being replaced by crossover and mutation. The iteration is terminated when it reaches specified stopping criteria. In the paper, we use GA to determine the optimal configurations of sizes and placements of DGs in the microgrid system on Jeju Island. The simulation and codification of GA are implemented on Matlab Optimization Toolbox Genetic Algorithm Section⁴. The procedure is illustrated as below:

Initialization: The initial population is generated randomly. Each population contains a number of chromosomes. The numbers of chromosomes are 50 and 100 respectively, in order to make a comparison of the results for different initialization. Each chromosome has 6 genes, which are $[\alpha_W \mid \alpha_S \mid B \mid \alpha_T \mid l_W \mid l_B]$.

Selection: The chromosomes in the population are retained if they are within the constraints in Equation 8. Then their fitness values are computed and compared. The fitness value is the value of the objective function in Equation 8.

Reproduction: New populations are replaced or modified by two reproduction methods—crossover and mutation. These are two main genetic operators that can derive a “child” from a “parents”. In crossover, several functions such as single point, two points, intermediate and arithmetic methods can be chosen to improve the simulation. In mutation, several functions such as uniform and non-uniform methods can be chosen as well. In uniform, the default rate is 0.01 but allows specification. With the new population, the algorithm goes back to Step 2 and check if the chromosomes satisfy the constraints and are compared by the fitness value again.

Termination: The algorithm is terminated when either one of the two requirements is satisfied. 1) The iteration time/generation reaches 100 and 200 respectively; 2) The difference between the first smallest and second smallest fitness value is equal to or smaller than 10^{-3} and 10^{-6} respectively. Then the solution which has the smallest fitness value is found as the optimal final point.

V. SIMULATION RESULTS

A. Generation Profiles

Fig. 9 presents the simulated hourly wind power generation by 1 MW WTs respectively on spot 1 and spot 2 of Jeju

Island in Year 2013. It follows the same trend as the variation of wind speed and reaches its peak at 0.836 MW for spot 1 and 0.457 MW for spot 2.

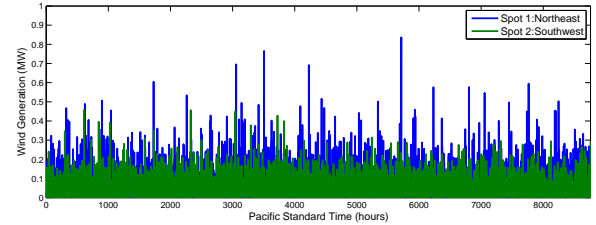

Figure 9. Wind power generation in Year 2013 on Jeju Island

Fig. 10 presents the simulated hourly solar power generation by 1 MW PV panels on spot 1 of Jeju Island in Year 2013. It follows the same trends as solar irradiation and reaches its peak at 0.998 MW.

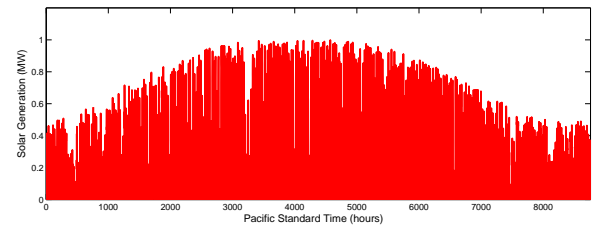

Figure 10. Solar power generation in Year 2013 on Jeju Island

Fig. 11 gives an example of how the BA management system works by balancing supply and demand during 24 hours on Jan 1st, 2013, where $\alpha_W = 500MW$, $\alpha_S = 500MW$, $B = 500MWh$, $\alpha_T = 50MW$, $l_W = spot1$ and $l_B = spot1$. In the figure, from 0:00-17:00, supply from DGs and thermal at each hour can satisfy demand thus BA does not need to discharge. After 17:00, supply is reduced so BA discharge energy to feed demand. In the 24 hours, no LS event happens which means that supply and demand are well balanced.

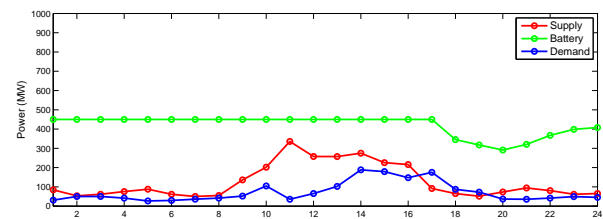

Figure 11. Supply, battery and demand curves on Jan 1st, 2013 on Jeju Island

B. Optimization Results by GA

The test bed is the power grid on Jeju Island in Fig. 2. The inputs to GA are objective function, number of decision variables, lower bounds, upper bounds, linear inequality and equality constraints, and nonlinear constraints including the wind, solar generation, BA control algorithm, calculation of $Prob_{LS}$. The outputs of GA are the final points of decision

⁴<http://www.mathworks.com/discovery/genetic-algorithm.html>

variables and corresponding best fitness values. During the simulation, the numbers of the chromosomes in initialization, the parameters of the genetic operators and the termination criteria are modified manually several times as discussed in Section IV-C, in order to improve the algorithm implementation. The final optimization results are shown as below.

Table V lists four optimal configurations of DGs that are within the constraints and have minimum cost amounts determined by GA. Among these, the first one has minimum cost of $\$4.098 \times 10^9$ to install, operate and maintain the system, which is the optimal configuration of DGs ($\alpha_W = 382MW$, $\alpha_S = 713MW$, $B = 500MWh$, $\alpha_T = 100MW$, $l_W = spot1$ and $l_B = spot1$) for Jeju island power grid.

Table V
OPTIMAL CONFIGURATIONS SOLVED BY GENETIC ALGORITHM

Scenario	1	2	3	4
$\alpha_W (MW)$	382	401	400	380
$\alpha_S (MW)$	713	699	700	715
$B (MWh)$	500	500	500	500
$\alpha_T (MW)$	100	100	100	100
l_W	Spot1	Spot1	Spot1	Spot1
l_B	Spot1	Spot1	Spot1	Spot1
$Prob_{LS}$	2.99%	2.99%	2.99%	2.99%
$C(\$)$	4.098×10^9	4.099×10^9	4.100×10^9	4.100×10^9

Table VI gives a comparison of some important factors in measuring the performance of the configurations between Scenario 1 with DG integration in Table V and the original system without DG. According to the table, there are at least four points that are of interest.

- Power loss is reduced by integration of DG because DGs are always located at distribution part. It avoids high power losses caused by transmission lines.
- The amount of CO_2 emission is reduced as well because the size of thermal generation is largely reduced. The penetration of DGs compensates the reduction of thermal.
- Voltage constraints are both satisfied in two scenarios.
- $Prob_{LS}$ is smaller than 3% which satisfies the nonlinear constraint.

Table VI
COMPARISON BETWEEN WITH DG AND WITHOUT DG

Results	with DG of Scenario 1	without DG
P_{Loss}	$\leq P_{original}$	$P_{original}$
CO_2 Emission	$1.07 \times 10^9 Lbs/year$	$2.51 \times 10^9 Lbs/year$
V_i	within safe range	within safe range
$Prob_{LS}$	$\leq 3\%$	N.A.

C. Validation of the Performance

In the section, the authors use NLP to roughly find out the optimal configurations within constraints and compare with the results by GA, in order to validate the performance of the GA approach. It is easily concluded that the size of thermal generation should be maximum tolerable amount, in order to provide energy but benefit environment. Therefore the size of thermal generation is fixed as 100 MW. The difference for placing WT is that the wind speed is different at two spots. The

difference for placing BA is that electricity might be wasted by transmission lines when BA is far from DGs. Fig. 12-15 respectively show all the points that are within the constraints and have the top minimum cost amount, in the following four scenarios:

- Scenario I: $\alpha_T = 100MW$, $l_W = spot1$, $l_B = spot1$;
- Scenario II: $\alpha_T = 100MW$, $l_W = spot1$, $l_B = spot2$;
- Scenario III: $\alpha_T = 100MW$, $l_W = spot2$, $l_B = spot1$;
- Scenario IV: $\alpha_T = 100MW$, $l_W = spot2$, $l_B = spot2$.

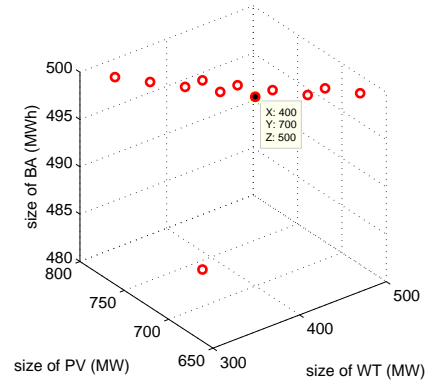

Figure 12. Distribution of points within constraints and with minimum cost function in Scenario I

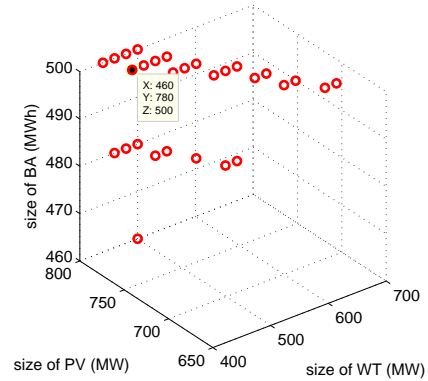

Figure 13. Distribution of points within constraints and with minimum cost function in Scenario II

In these figures, the best points with minimum objective function are marked up and summarized in Table VII. Among the four best points, the first scenario has minimum cost of $\$4.10 \times 10^9$, which means that the combination of $\alpha_W = 400MW$, $\alpha_S = 700MW$, $B = 500MWh$, $\alpha_T = 100MW$, $l_W = spot1$ and $l_B = spot1$ is the optimal configuration for Jeju Island power grid determined by this method.

Compared to the results in Section V-B, GA solves the problem with better performance than NLP in several points:

- Accuracy: In both of the approaches, several simulations are needed to narrow down the range of feasible sets. However, GA takes less times to find out the acceptable range. In addition, the optimal configurations by GA are

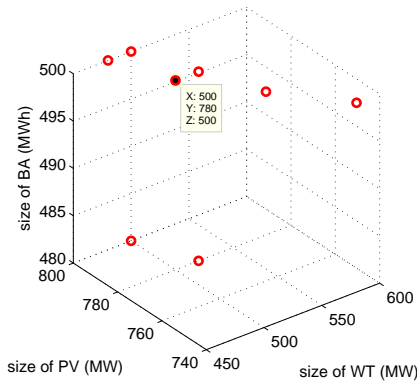

Figure 14. Distribution of points within constraints and with minimum cost function in Scenario III

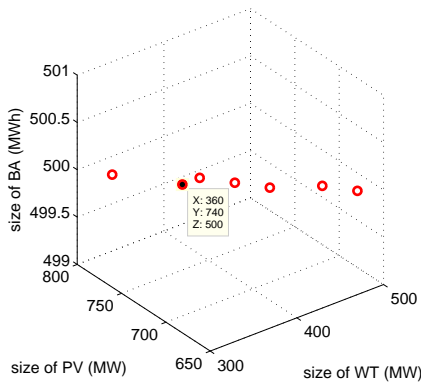

Figure 15. Distribution of points within constraints and with minimum cost function in Scenario IV

more accurate than NLP, because the amount of cost to build the system is less.

- **Stability:** Matlab Optimization Toolbox Genetic Algorithm allows users to specify desirable values in several options, such as number of initial population, function to create generation, crossover and mutation, and stopping criteria. The adjustments of the parameters provide a more stable environment in solving the problem.
- **Efficiency:** It takes less than 5 minutes for GA to optimize while the computation time goes over 5 minutes for NLP if step size for iteration is 10.

VI. CONCLUSIONS

The objective of the paper is to study and propose an approach to optimally integrate DGs using the Jeju Island power

Table VII
OPTIMAL CONFIGURATIONS IN FOUR SCENARIOS USING NLP

Scenario	1	2	3	4
$\alpha_W (MW)$	400	460	500	360
$\alpha_S (MW)$	700	780	780	740
$B (MWh)$	500	500	500	500
$Prob_{LS}$	2.99%	2.92%	2.95%	2.98%
$C(\$)$	4.10×10^9	4.60×10^9	4.72×10^9	4.14×10^9

grid as test bed. The authors have carried out a careful study on the current status of art on the methods of solving such optimization problem. It is found out that heuristic approaches, especially genetic algorithm, have been researched as a more promising research area, compared to traditional methods. The algorithms of modeling wind, solar power generation, battery control management and demand distribution are explicitly introduced and explained with equations and figures. The optimization problem is formulated as a comprehensive objective function that describes the cost to install, operate and maintain the hybrid renewable system subject to some constraints, such as the lower and upper bounds of the decision variables, the limitation on power loss, the requirements on voltage drop and tolerable risk level. Genetic algorithm is used to study the input data which includes renewable generation and demand profiles of Jeju Island, create initial satisfactory population, mutate its chromosomes by iterations, and determine the optimal sizes and placements of DGs for the Jeju Island power system. The optimization results by GA are validated by nonlinear programming. From the optimization results that are provided by GA and NLP, it is concluded that GA performs better not only in accuracy, stability, but also in efficiency.

Importantly, this paper proposes a comprehensive objective function with practical constraints which take all the important factors that will impact the reliability of the power grid into account. The significant contribution compared to existing research on optimization of DGs on Jeju Island is that wind, solar and BA are taken into account together and the process of optimizing the sizes and placements of DGs on Jeju Island is analyzed and compared by two methods GA and NLP.

In the future, the next step is to take the constraints on dynamical power flow into consideration when designing the new power system for Jeju Island or any other similar microgrids. In the meanwhile, more types of DGs other than WT, PV and BA will become decision variables in the optimal configuration. A more comprehensive optimization problem will be studied and solved thoroughly.

REFERENCES

- [1] Huang, Rui, et al. "Optimal design of hybrid energy system with PV/wind turbine/storage: A case study." Smart Grid Communications (SmartGridComm), 2011 IEEE International Conference on. IEEE, 2011.
- [2] Baños, R., et al. "Optimization methods applied to renewable and sustainable energy: A review." Renewable and Sustainable Energy Reviews 15.4 (2011): 1753-1766.
- [3] Shin, Byoung-Yoon, et al. "A Study on Jeju Power System Considering Smart Grid Elements." The Journal of International Council on Electrical Engineering 3.4 (2013): 300-305.
- [4] Nema, Pragma, R. K. Nema, and Saroj Rangnekar. "A current and future state of art development of hybrid energy system using wind and PV-solar: A review." Renewable and Sustainable Energy Reviews 13.8 (2009): 2096-2103.
- [5] Lu, Bo, and Mohammad Shahidehpour. "Short-term scheduling of battery in a grid-connected PV/battery system." Power Systems, IEEE Transactions on 20.2 (2005): 1053-1061.
- [6] Ekren, Orhan, and Banu Y. Ekren. "Size optimization of a PV/wind hybrid energy conversion system with battery storage using simulated annealing." Applied Energy 87.2 (2010): 592-598.
- [7] Logenthiran, Thillainathan, et al. "Optimal sizing of distributed energy resources for integrated microgrids using evolutionary strategy." Evolutionary Computation (CEC), 2012 IEEE Congress on. IEEE, 2012.

- [8] Koutroulis, Eftichios, et al. "Methodology for optimal sizing of stand-alone photovoltaic/wind-generator systems using genetic algorithms." *Solar energy* 80.9 (2006): 1072-1088.
- [9] Tafreshi, S. M. M., et al. "Optimal unit sizing of Distributed Energy Resources in MicroGrid using genetic algorithm." *Electrical Engineering (ICEE), 2010 18th Iranian Conference on*. IEEE, 2010.
- [10] Senjyu, Tomonobu, et al. "Optimum configuration for renewable generating systems in residence using genetic algorithm." *Energy Conversion, IEEE Transactions on* 21.2 (2006): 459-466.
- [11] Alarcón-Rodríguez, Arturo D. A multi-objective planning framework for analysing the integration of distributed energy resources. Diss. University of Strathclyde Glasgow, 2009.
- [12] Akorede, M. F., et al. "A review of strategies for optimal placement of distributed generation in power distribution systems." *Research Journal of Applied Sciences* 5.2 (2010): 137-145.
- [13] Wang, Caisheng, and M. Hashem Nehrir. "Analytical approaches for optimal placement of distributed generation sources in power systems." *Power Systems, IEEE Transactions on* 19.4 (2004): 2068-2076.
- [14] Prommee, W.; Ongsakul, W., "Optimal multi-distributed generation placement by adaptive weight particle swarm optimization," *Control, Automation and Systems*, 2008. ICCAS 2008. International Conference on , vol., no., pp.1663,1668, 14-17 Oct. 2008
- [15] de Souza, Benemar A., and João MC de Albuquerque. "Optimal placement of distributed generators networks using evolutionary programming." *Transmission & Distribution Conference and Exposition: Latin America, 2006. TDC'06. IEEE/PES. IEEE, 2006.*
- [16] Kim, Kyu-Ho, et al. "Dispersed generator placement using fuzzy-GA in distribution systems." *Power Engineering Society Summer Meeting, 2002 IEEE. Vol. 3. IEEE, 2002.*
- [17] Parizad, A., A. Khazali, and M. Kalantar. "Optimal placement of distributed generation with sensitivity factors considering voltage stability and losses indices." *Electrical Engineering (ICEE), 2010 18th Iranian Conference on*. IEEE, 2010.
- [18] Tautiva, Camilo, Angela Cadena, and Fredy Rodriguez. "Optimal placement of distributed generation on distribution networks." *Universities Power Engineering Conference (UPEC), 2009 Proceedings of the 44th International. IEEE, 2009.*
- [19] Masoum, Mohammad AS, S. M. Mousavi Badejani, and Mohsen Kalantar. "Optimal placement of hybrid PV-wind systems using genetic algorithm." *Innovative Smart Grid Technologies (ISGT), 2010. IEEE, 2010.*
- [20] Alarcon-Rodríguez, Arturo, Graham Ault, and Stuart Galloway. "Multi-objective planning of distributed energy resources: A review of the state-of-the-art." *Renewable and Sustainable Energy Reviews* 14.5 (2010): 1353-1366.
- [21] Hernández, J. C., A. Medina, and F. Jurado. "Optimal allocation and sizing for profitability and voltage enhancement of PV systems on feeders." *Renewable Energy* 32.10 (2007): 1768-1789.
- [22] Le, An DT, et al. "Optimal distributed generation parameters for reducing losses with economic consideration." *Power Engineering Society General Meeting, 2007. IEEE. IEEE, 2007.*
- [23] Ghosh, Sudipta, S. P. Ghoshal, and Saradindu Ghosh. "Optimal sizing and placement of distributed generation in a network system." *International Journal of Electrical Power & Energy Systems* 32.8 (2010): 849-856.
- [24] Haesen, Edwin, et al. "Optimal placement and sizing of distributed generator units using genetic optimization algorithms." *Electrical Power Quality and Utilisation Journal* 11.1 (2005): 97-104.
- [25] Borges, Carmen LT, and Djalma M. Falcao. "Optimal distributed generation allocation for reliability, losses, and voltage improvement." *International Journal of Electrical Power & Energy Systems* 28.6 (2006): 413-420.
- [26] Wu, Liang, et al. "Probabilistic reliability evaluation of power systems including wind turbine generators using a simplified multi-state model: A case study." *Power & Energy Society General Meeting, 2009. PES'09. IEEE. IEEE, 2009.*
- [27] Kim, Eel-Hwan, et al. "Impact analysis of wind farms in the Jeju Island power system." *Systems Journal, IEEE* 6.1 (2012): 134-139.
- [28] Park Man Geun. "Experience of Jeju smart grid test-bed&national strategy." the 3rd session "Island case studies", 2013.
- [29] Park, Jin-woo, Young-ho Park, and Seung-il Moon. "Instantaneous wind power penetration in Jeju Island." *Power and Energy Society General Meeting-Conversion and Delivery of Electrical Energy in the 21st Century, 2008 IEEE. IEEE, 2008.*
- [30] Deshmukh, M. K., and S. S. Deshmukh. "Modeling of hybrid renewable energy systems." *Renewable and Sustainable Energy Reviews* 12.1 (2008): 235-249.
- [31] Joselin Herbert, G. M., et al. "A review of wind energy technologies." *Renewable and sustainable energy Reviews* 11.6 (2007): 1117-1145.
- [32] Singh, Mohit, and Surya Santoso. *Dynamic models for wind turbines and wind power plants*. National Renewable Energy Laboratory, 2011.
- [33] Parida, Bhubaneswari, S. Iniyan, and Ranko Goic. "A review of solar photovoltaic technologies." *Renewable and Sustainable Energy Reviews* 15.3 (2011): 1625-1636.
- [34] Rui Huang, Eun-Kyu Lee, Chi-Cheng Chu, Rajit Gadh. "Integration of IEC 61850 into a Distributed Energy Resources System in a Smart Green Building", 2014 IEEE PES General Meeting, National Harbor, MD, USA, 27-31 July 2014.
- [35] Li, Huijuan, et al. "Real and reactive power control of a three-phase single-stage PV system and PV voltage stability." *Power and Energy Society General Meeting, 2012 IEEE. IEEE, 2012.*
- [36] Li, Na, Lijun Chen, and Steven H. Low. "Optimal demand response based on utility maximization in power networks." *Power and Energy Society General Meeting, 2011 IEEE. IEEE, 2011.*
- [37] Yang, Hongxing, et al. "Optimal sizing method for stand-alone hybrid solar-wind system with LPSP technology by using genetic algorithm." *Solar energy* 82.4 (2008): 354-367.
- [38] Basso, Thomas S., and Richard DeBlasio. "IEEE 1547 series of standards: interconnection issues." *Power Electronics, IEEE Transactions on* 19.5 (2004): 1159-1162.
- [39] Kumar, Manoj, et al. "Genetic algorithm: Review and application." *International Journal of Information Technology and Knowledge Management* 2.2 (2010): 451-454.
- [40] Tegen, S., et al. "2011 Cost of Wind Energy." *Contract* 303 (2013): 275-3000.
- [41] Feldman, David, et al. *Photovoltaic (PV) pricing trends: historical, recent, and near-term projections*. No. DOE/GO-102012-3839. National Renewable Energy Laboratory (NREL), Golden, CO., 2012.

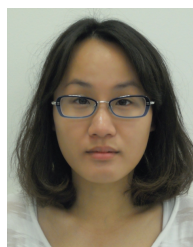

Rui Huang is a Ph.D. candidate in Smart Grid Energy Research Center, Mechanical Engineering, University of California, Los Angeles. She received her M.S. degree in Electrical Engineering, California Institute of Technology, U.S. in 2011 and B.S. degree in Electrical Engineering, Tsinghua University, China in 2009. Her interest is in renewable energy prediction, integration and optimization in the micro-grids. Her research is supported by Korea Institute of Energy Research.

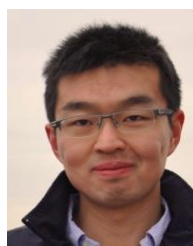

Yubo Wang received his B.S degree from Southeast University, China in 2011 and M.S degree from University of California, Los Angeles in 2012, both in Electrical Engineering. He is currently working towards his Ph.D. degree in the Smart Grid Energy Research Center in University of California, Los Angeles. He has keen interests in the fields of Vehicle-to-Grid (V2G) as well as motors control. He is involved in the Electrical Vehicle demonstration project of DOE and LADWP.



Chi-Cheng Chu is currently a project lead at Henry Samueli School of Engineering and Applied Science at University of California at Los Angeles. He is a seasoned research manager who supervised and steered multiple industry and academia research projects in the field of Smart Grid, RFID technologies, Mobile Communication (WiFi, Bluetooth, Zigbee, GPRS, 3G), Media Entertainment (DRM, Mobile music, video, imaging, gaming, etc.), 3D/2D Visualization of scientific data (astronomical, power system, industry process data, etc) and Computer Aided Design. He received his Ph.D. degree from University of Wisconsin – Madison on 2001 and B.S. degree from National Taiwan University on 1990.



Rajit Gadh is a Professor at the Henry Samueli School of Engineering and Applied Science at UCLA, and the Founding Director of the UCLA Smart Grid Energy Research Center. His research interests include Smart Grid Architectures, Smart wireless communications, sense and control for Demand Response, Micro Grids and Electric Vehicle Integration into the Grid, Mobile Multimedia, Wireless and RFID Middleware, RFID and Wireless sensors for Tracking Assets, RF-sensor-control interfaces, and Visualization. He has a Doctorate degree from Carnegie Mellon University (CMU), a Masters from Cornell University and a Bachelor's degree from IIT Kanpur. He has taught as a visiting researcher at UC Berkeley, has been an Assistant, Associate and Full Professor at University of Wisconsin-Madison, and did his sabbatical as a visiting researcher at Stanford University for a year.



Yu-jin Song received his B.S. and M.S. degrees in electrical engineering from Yonsei University, Seoul, Korea in 1988 and 1991, and Ph.D. degree in electrical engineering from Texas A&M University at College Station, Texas in 2004. He has been a principal engineer at Korea Institute of Energy Research since 2004. His research interests are primarily in advanced power electronics applied to distributed power generation system with renewable energy sources, micro grid and power quality issues.